



**NARUTO
SHIPPUDEN**





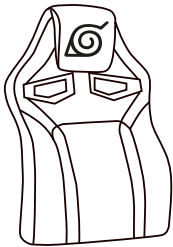
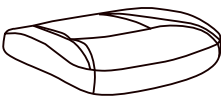
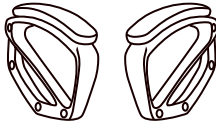
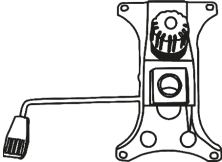

GAMING CHAIR

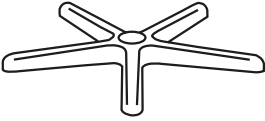

**USER MANUAL
KONIX**

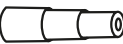
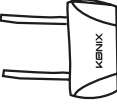

<p>Ax1</p> 	<p>Bx1</p> 	<p>Cx2</p> 
<p>Dx1</p> 	<p>Ex1</p> 	<p>Fx1</p> 

<p>Gx8</p>  <p>M6x30mm</p>	<p>Hx4</p>  <p>M6x20mm</p>	<p>Ix4</p> 	<p>Jx8</p> 
<p>Kx1</p> 	<p>Lx5</p> 	<p>Mx1</p> 	<p>Nx1</p> 

1

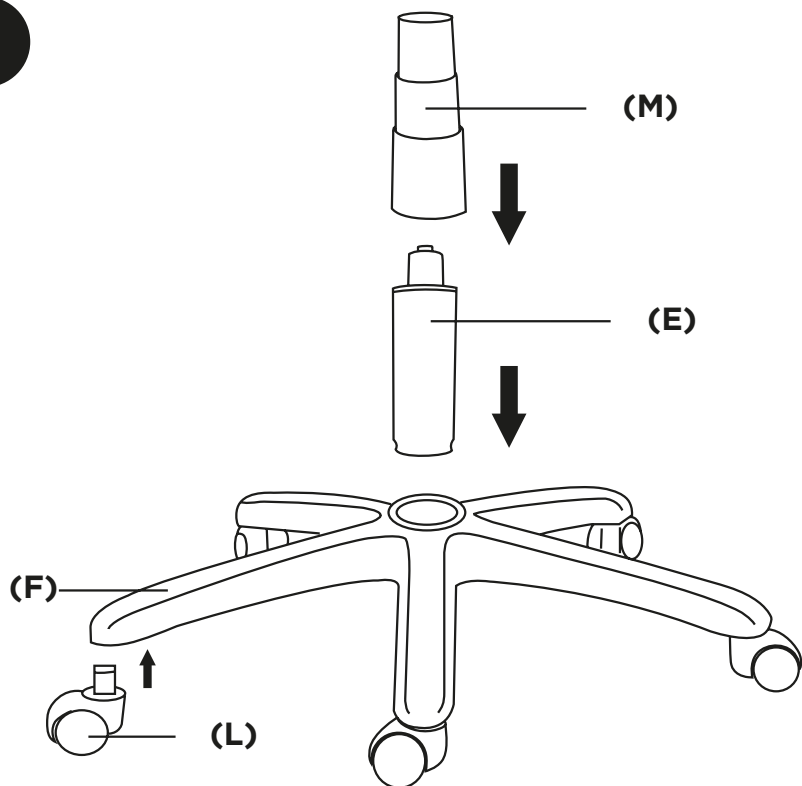

2

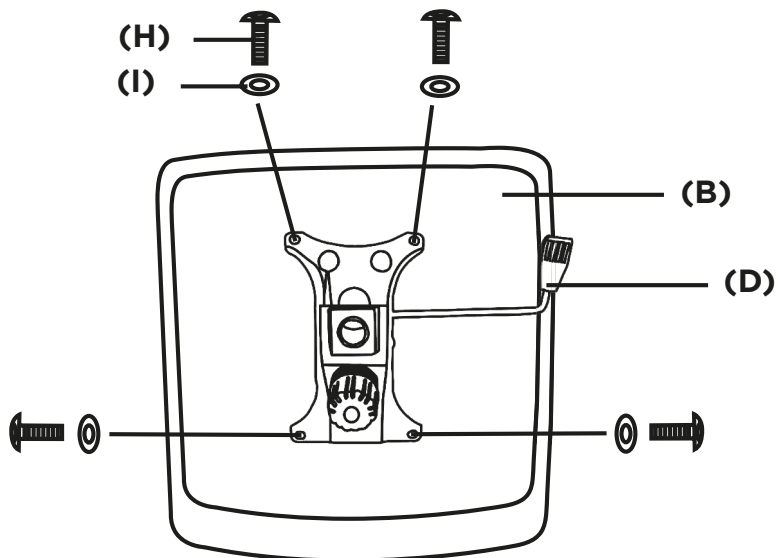

3

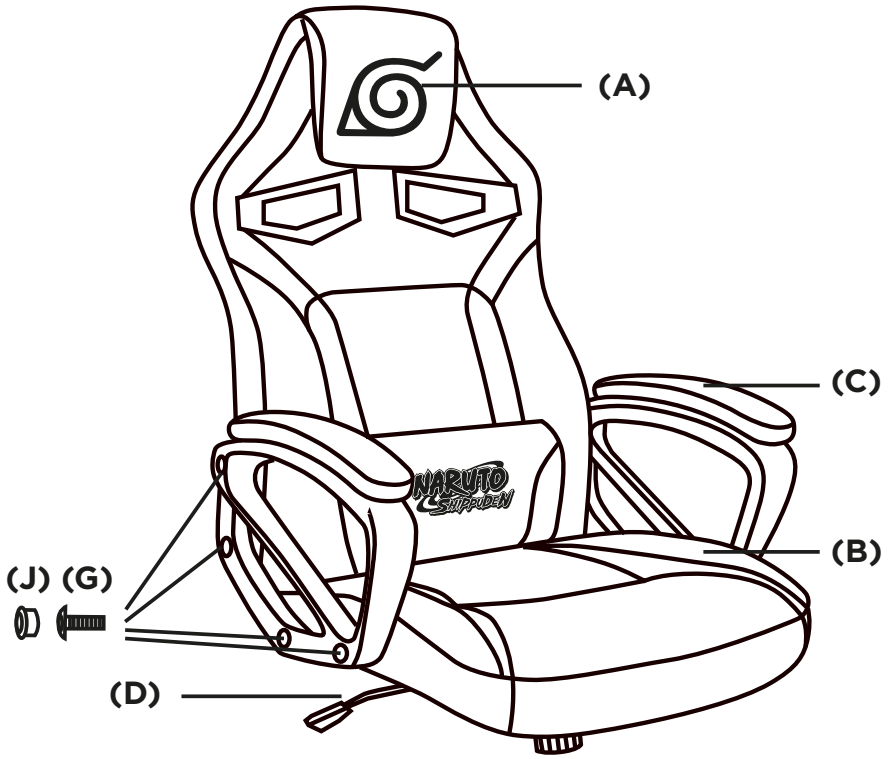

4

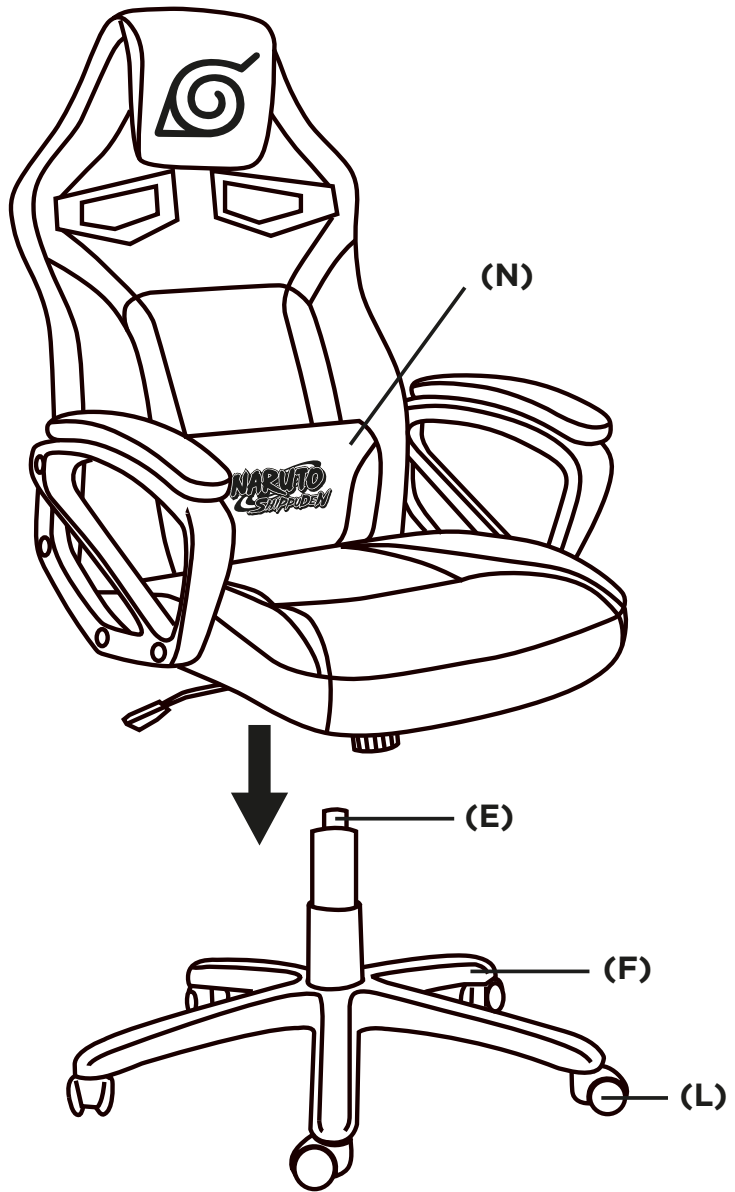

5



KONIX

www.konix-interactive.com

©2022 Konix. Innelec Multimedia - Konix, 45 rue Delizy, 93692 Pantin Cedex, FRANCE. The Konix and Drakkar brands and logos are trademarks of Innelec Multimedia S.A. All other trademarks are the property of their respective owners. All rights reserved. Made in PRC.

©2022 Konix. Innelec Multimedia - Konix, 45 rue Delizy, 93692 Pantin Cedex, FRANCE. Les marques et logos Konix et Drakkar sont des marques de commerce d'Innelec Multimedia S.A. Toutes les autres marques de commerce appartiennent à leurs propriétaires respectifs. Tous droits réservés. Fabriqué en RPC.

