

MYTHICS®

Gaming Earbuds PS-i450

for PS4™



USER MANUAL

KONIX

UK

MYTHICS PS-i450

Gaming earbud for PC,
smartphones and console gaming

UK

CONTENT

- Gaming earbuds
- Flexible pole microphone
- 1.5m Splitter extension for PC gaming
- Carry bag

PRODUCT FEATURES

Headphone:

- Driver diameter: 10 mm
- Sensitivity: 95+/-3dB
- Impedance: 16 Ω
- Frequency: 20 ~ 20 000 Hz



Microphone:

- Mic dimension: \varnothing 4,0 x 1,5mm
- Mic sensitivity: -38 +/- DB3
- Mic impedance: 2,2k Ω
- Headset interface: 3.5mm
- Cable length: 1,2m

UK

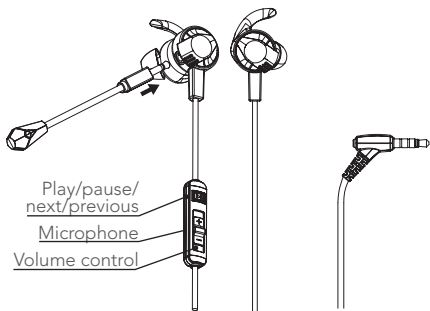
REMOTE CONTROL



Next track: double press 
Previous track: triple press 

Set up on PC/MAC and Mobile

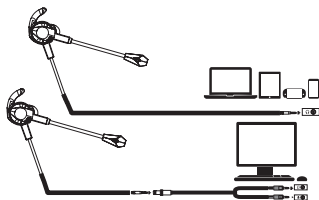

Set up on X ONE



Set up on PS4



UK

CAUTION FOR USE:

- Do not use the headset with a device other than that for which it is intended
- Do not disassemble the product
- Do not expose this product to moisture or any other liquid.
- Do not expose this product to dust, direct sunlight or temperature shock.
- Do not throw this product onto a fire.



Warning: Prolonged listening to music at high volume can cause permanent hearing damage

FR

MYTHICS PS-i450

Gaming earbud for PC,
smartphones and console gaming

FR

CONTENU :

- Ecouteurs gaming
- Antenne microphone amovible
- Doubleur de 1.5m pour jouer sur PC
- Housse de transport

SPÉCIFICITÉS TECHNIQUES

Casque/écouteurs :

- Diamètre des HP : 10 mm
- Sensibilité : 95+/-3dB
- Impédance : 16 Ω
- Fréquence : 20 ~ 20 000 Hz

Micro :

- Taille du micro : \varnothing 4,0 x 1,5mm
- Sensibilité du micro : -38 +/- DB3
- Impédance du micro : 2,2k Ω
- Connectique : 3.5mm
- Longueur du câble : 1,2m

TÉLÉCOMMANDE

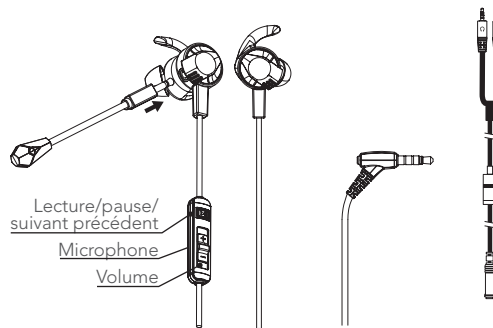

Piste suivante : Appuyez deux fois sur le bouton 

Piste précédente : Appuyez trois fois sur le bouton 

Installation sur PC/MAC et mobile

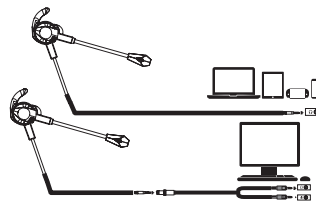

FR**DE**

MYTHICS PS-i450

Gaming earbud for PC,
smartphones and console gaming

Installation sur XBOX ONE



Installation sur PS4

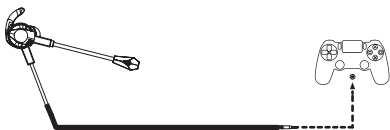

PRÉCAUTION D'EMPLOI :

- N'utilisez pas le casque avec un appareil autre que celui pour lequel il est destiné
- Ne démontez pas le produit
- N'exposez pas ce produit à l'humidité ou à tout autre liquide.
- N'exposez pas ce produit à la poussière, aux rayons directs du soleil ou à tout choc thermique.
- Ne jetez pas ce produit dans le feu.



Attention : L'écoute prolongée de musique à un volume trop élevé peut causer de troubles auditifs irréversibles

INHALT :

- Gaming Ohrhörer
- Flexibles Pol-Mikrofon
- 1,5 m Verteiler Erweiterung für PC-Spiele
- Tragetasche

PRODUKTSPEZIFIKATIONEN

Headset/Ohrhörer :

- Treiberdurchmesser : 10 mm
- Empfindlichkeit : 95+/-3dB
- Impedanz : 16 Ω
- Frequenz : 20 ~ 20 000 Hz



Mikrofon :

- Mikrofon-Abmessungen : \varnothing 4,0 x 1,5mm
- Mikrofon-Empfindlichkeit : -38 +/- DB3
- Mikrofon-Impedanz : 2,2k Ω
- Schnittstelle für kopfhörer : 3.5mm
- Kabellänge : 1,2m

DE

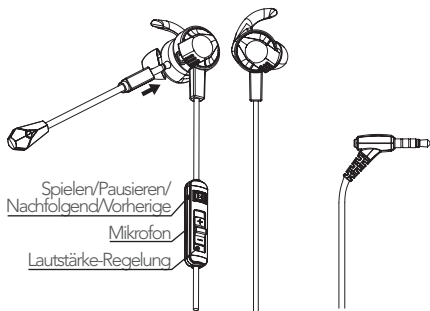
FERNSTEUERUNG



Nächster Titel: Doppelklick 
Vorheriger Titel: Dreifachklick 

Einrichtung auf PC/MAC und Mobiltelefon

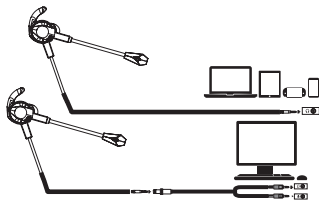

Set up on X ONE

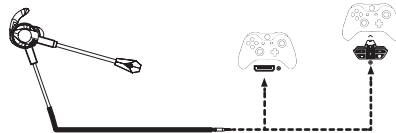

Set up on PS4

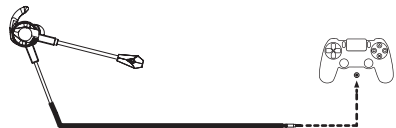

VORSICHTSMAßNAHMEN BEI DER VERWENDUNG :

- Verwenden Sie das Headset nicht mit einem anderen Gerät als dem, für das es bestimmt ist
- Demontieren Sie das Produkt nicht
- Setzen Sie dieses Produkt keiner Feuchtigkeit oder anderen Flüssigkeiten aus.
- Setzen Sie dieses Produkt keinem Staub, direkter Sonneneinstrahlung oder extremen Temperaturschwankungen aus.
- Bringen Sie das Produkt nicht mit Feuer in Verbindung.



Warnung: Längeres Hören von Musik bei hoher Lautstärke kann zu permanentem Hörschäden führen. Schäden.

DE

ES

MYTHICS PS-i450

Gaming earbud for PC,
smartphones and console gaming

ES

CONTENIDO :

- Auriculares gaming
- Micrófono de brazo flexible
- Extensión splitter 1,5 m para juegos en PC
- Bolsa de transporte

ESPECIFICACIONES DEL PRODUCTO

Auriculares / cascos :

- Diámetro del driver : 10 mm
- Sensibilidad : 95+/-3dB
- Impedancia : 16 Ω
- Frecuencia : 20 ~ 20 000 Hz

Micro :

- Medidas del micrófono : \varnothing 4,0 x 1,5mm
- Sensibilidad del micrófono : -38 +/- DB3
- Impedancia del micrófono : 2,2k Ω
- Interfaz de los auriculares : 3.5mm
- Longitud del cable : 1,2m

CONTROL REMOTO

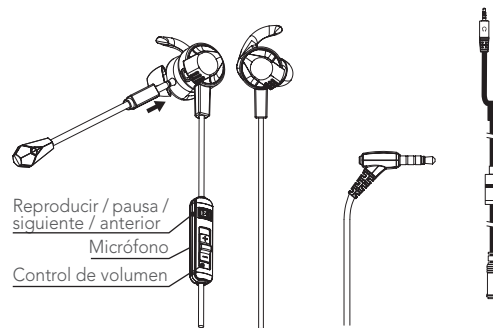

Pista siguiente: doble pulsación 

Pista anterior: triple pulsación 

Configuración en PC/MAC y móvil

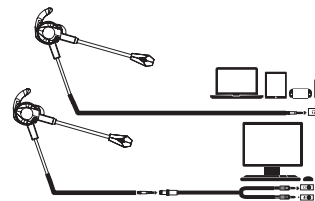

ES**PT**

MYTHICS PS-i450

Gaming earbud for PC,
smartphones and console gaming

Configurar en X ONE



Configurar en PS4



PRECAUCIONES DE USO :

- No utilice el auricular con un dispositivo para el que esté destinado.
- No desmonte el producto.
- No exponga este producto a la humedad ni a ningún otro líquido.
- No exponga este producto al polvo, a la luz solar directa ni a bruscos cambios de temperatura.
- No arroje este producto al fuego.



Advertencia: La escucha prolongada de música a un volumen alto puede causar un daño permanente a la audición.

CONTEÚDO :

- Auscultadores de gaming
- Microfone de haste flexível
- Extensão com separação de 1,5 m para PC gaming
- Bolsa para transporte

ESPECIFICAÇÃO DO PRODUTO

Auriculares / cascos :

- Diâmetro do altifalante : 10 mm
- Sensibilidade : 95+/-3dB
- Impedância : 16 Ω
- Frequência : 20 ~ 20 000 Hz

Micro :

- Dimensões do microfone : Ø 4,0 x 1,5mm
- Sensibilidade do microfone : -38 +/- DB3
- Impedância do microfone : 2,2k Ω
- Interface dos auscultadores : 3.5mm
- Comprimento do fio : 1,2m

PT

CONTROLO REMOTO

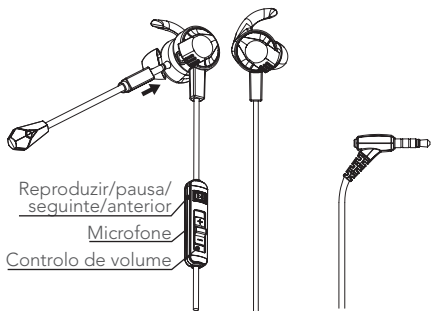

Faixa seguinte: premir duas vezes 
Faixa anterior: premir três vezes 

Configurar em PC/MAC e Móvel

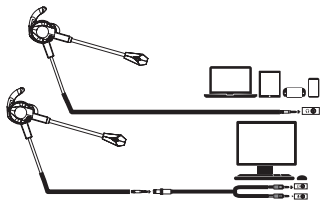

Configurar na X ONE

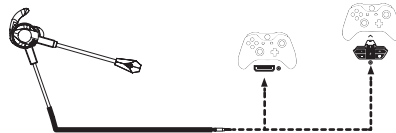

Configurar na PS4



PT

AVISOS DE UTILIZAÇÃO :

- Não use os auscultadores com um dispositivo diferente daquele para o qual foram projetados
- Não desmonte o produto
- Não exponha este produto à humidade ou a qualquer outro líquido.
- Não exponha este produto a poeiras, luz solar direta ou choques de temperatura.
- Não deite este produto no fogo.



Aviso: a audição prolongada de música com volume muito alto pode causar danos de audição permanentes.

IT

MYTHICS PS-i450

Gaming earbud for PC,
smartphones and console gaming

IT

CONTENUTO :

- Auricolari da gioco
- Microfono ad asta flessibile
- Prolunga sdoppiatore da 1,5 m per giochi PC
- Borsa per il trasporto

SPECIFICHE DEL PRODOTTO

Cuffie/auricolari :

- Diametro del driver : 10 mm
- Sensibilità : 95+/-3dB
- Impedenza : 16 Ω
- Frequenza : 20 ~ 20 000 Hz

Microfono :

- Dimensione microfono : \varnothing 4,0 x 1,5mm
- Sensibilità microfono : -38 +/- DB3
- Impedenza microfono : 2,2k Ω
- Interfaccia cuffie : 3.5mm
- Lunghezza cavo : 1,2m

TELECOMANDO

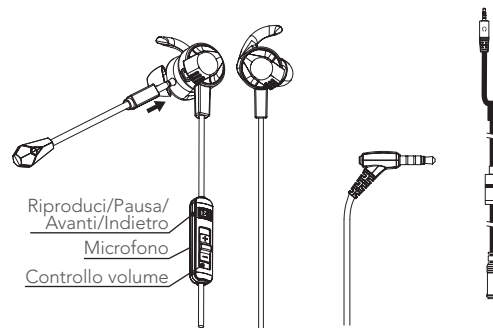

Brano successivo: premi due volte 

Brano precedente: premi tre volte 

Configura su PC/MAC e dispositivo mobile

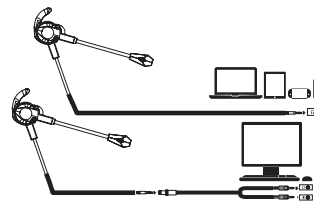

IT

Configura su X ONE

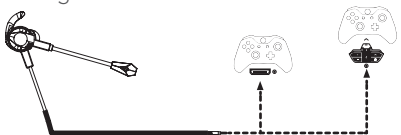

Configura su PS4

**PRECAUZIONI PER L'USO :**

- Non utilizzare l'auricolare con un dispositivo diverso da quello a cui è destinato
- Non smontare il prodotto
- Non esporre questo prodotto a umidità o liquidi di altra natura.
- Non esporre questo prodotto a polvere, luce solare diretta o stress termico.
- Non gettare questo prodotto nel fuoco.



Avvertenza: l'ascolto prolungato di musica ad alto volume può provocare danni permanenti all'udito

MYTHICS PS-i450

Gaming earbud for PC,
smartphones and console gaming

NL**INHOUD :**

- Oordopjes voor gamen
- Flexibele boommicrofoon
- 1.5m Splitter-verlengkabel voor game op de PC
- Draagtas

PRODUCTSPECIFICATIE**Hoofdtelefoon/oortelefoon :**

- Diameter van driver : 10 mm
- Gevoeligheid : 95+/-3dB
- Impedantie : 16 Ω
- Frequentie : 20 ~ 20 000 Hz



Micro :

- Dimensie van microfoon : \varnothing 4,0 x 1,5mm
- Gevoeligheid van microfoon : -38 +/- DB3
- Impedantie van microfoon : 2,2k Ω
- Interface van koptelefoon : 3.5mm
- Kabellengte : 1,2m

NL

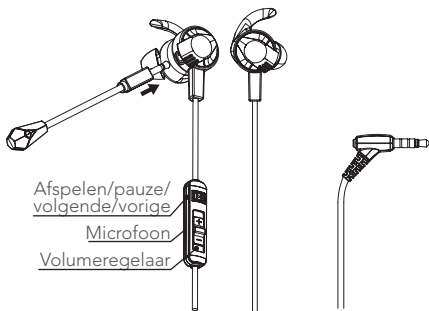
AFSTANDSBEDIENING



Volgend nummer: twee keer indrukken 
Vorige nummer: drie keer indrukken 

Instellen op PC/Mac en mobiel

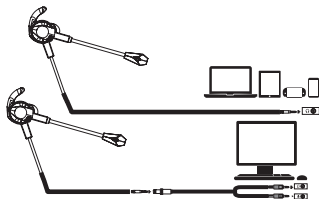

Instellen op X ONE

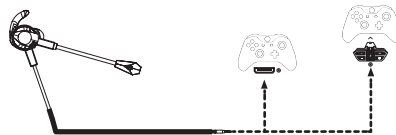

Instellen op PS4



LET OP VOOR GEBRUIK :

- Gebruik de hoofdtelefoon niet met een ander apparaat dan waarvoor het is bedoeld
- Demonteer het product niet
- Stel dit product niet bloot aan vocht of een andere vloeistof.
- Stel dit product niet bloot aan stof, direct zonlicht of een temperatuurschok.
- Gooi dit product niet in het vuur.



Waarschuwing: Langdurig luisteren naar muziek met een hoog volume kan tot permanente gehoorschade leiden.

NL

AR

MYTHICS PS-i450

Gaming earbud for PC,
smartphones and console gaming

المحتوي:

- سماعات أذن للألعاب
- ميكروفون بذرّاع مرّن
- وصلة مُقسّم بطول 1.5 متر لألعاب الكمبيوتر
- حقيبة حمل

مواصفات المنتج

- قطر مكبر الصوت : 10 مم
- الحساسية : +38/-3 ديسيبل
- المُعاوقة : 16 أوم
- التردد : 20 ~ 20000 هرتز
- أبعاد الميكروفون : 1,5 × 4,0 مم
- حساسية الميكروفون : 38 +/- DB3
- معاوقة الميكروفون : 2.2 كيلو أوم
- وسيط سماعة الرأس : 3.5 مم
- طول الكابل : 1,2 م

AR

جهاز التحكم عن بُعد

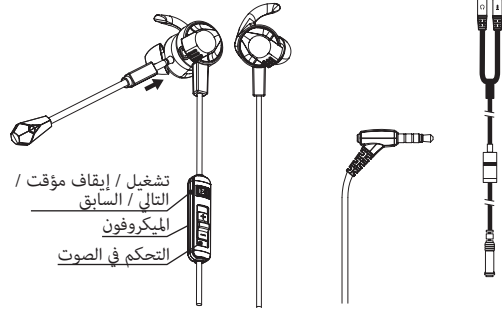

- ▶ المِساَر التّالِي: اضغط مرّتين
- ▶ المِساَر السّابِق: اضغط ثلاث مرّات

الإعداد على الكمبيوتر / جهاز MAC والهاتف المحمول

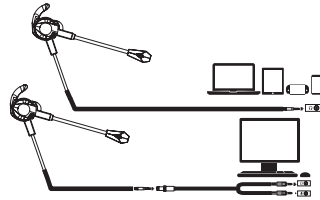

AR

الإعداد على X ONE

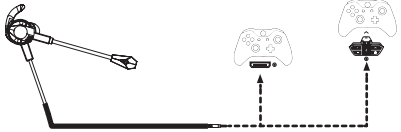

الإعداد على PS4



تنبيهات للاستخدام:

- لا تستخدم سماعة الرأس مع جهاز آخر غير الجهاز المخصصة له
- تجنب فك المنتج
- تجنب تعريض هذا المنتج للرطوبة أو أي سائل آخر.
- تجنب تعريض هذا المنتج للغبار أو أشعة الشمس المباشرة أو صدمة درجة الحرارة.
- تجنب وضع هذا المنتج على النار.



تحذير: قد يؤدي الاستماع لفترات طويلة إلى الموسيقى بمستوى صوت مرتفع إلى تلف دائم للسمع



Regulatory compliance information

- UK** If at any time in the future you should need to dispose of this product please note that: Waste electrical products should not be disposed of with household waste. Please recycle where facilities exist. Check with your Local Authority or retailer for recycling advice. (Waste Electrical and Electronic Equipment Directive)
- FR** Si dans l'avenir vous devez vous débarrasser de ce produit veuillez remarquer que : Les déchets électriques ne doivent pas être jetés avec les déchets ménagers. Veuillez recycler les produits dans une déchetterie. Consulter votre responsable local ou votre revendeur pour un conseil sur le recyclage. (Directive sur les déchets des équipements électriques et électroniques)
- DE** Sollten Sie dieses Produkt später einmal entsorgen müssen, beachten Sie bitte, dass elektrische, Abfallprodukte nicht mit dem Hausmüll entsorgt werden dürfen. Bitte führen Sie das Produkt dem Recycling zu, sofern eine entsprechende Einrichtung (Wertstoffhof) vorhanden ist. Fragen Sie bei Ihren Behörden vor Ort nach Möglichkeiten zum Recycling. (Richtlinie über Elektro- und Elektronik-Altgeräte).
- ES** Si en el futuro tiene que desechar este producto, tenga en cuenta que: Los residuos de productos eléctricos no se tienen que tirar con la basura domestica. Reciclelo en las instalaciones disponibles. Consulte a las Autoridades locales o al distribuidor para que le de instrucciones sobre el reciclaje. (Directiva sobre la eliminación de Aparatos Electronicos y Electricos).
- PL** Se a qualquer momento no futuro tiver que se desfazer deste produto, por favor note que: Os resíduos dos produtos eléctricos não deverão ser misturados juntamente com os resíduos domésticos. Por favor recicle onde seja possível. Verifique junto da sua Autoridade Local ou comerciante informação acerca de reciclagem. (Directiva sobre Resíduos de Equipamento Eléctrico e Electrónico).
- IT** Se in futuro dovesse essere necessario smaltire questo prodotto, si prega di notare che: I rifiuti elettrici non devono essere smaltiti insieme ai rifiuti domestici. Riciclare in apposite strutture. Verificare con l'Autorità locale o Rivenditore dove poter riciclare il dispositivo. (Direttiva sullo smaltimento dei rifiuti elettrici ed elettronici).
- NL** Als u in de toekomst wenst te ontdoen van dit product kunt u er rekening mee dat : Afgedankte elektrische producten mogen niet worden weggegooid bij het huishoudelijk afval. Recycle producten. Raadpleeg uw plaatselijke vertegenwoordiger of dealer voor advies over recycling. (Richtlijn betreffende afgedankte elektrische en elektronische apparatuur.





©2019 Konix. Innelec Multimedia - Konix, 45 rue Delizy, 93692 Pantin Cedex, FRANCE. The Konix and Mythics brands and logos are trademarks of Innelec Multimedia S.A. All other trademarks are the property of their respective owners. All rights reserved. Made in PRC.

©2019 Konix. Innelec Multimedia - Konix, 45 rue Delizy, 93692 Pantin Cedex, FRANCE. Les marques et logos Konix et Mythics sont des marques de commerce d'Innelec Multimedia S.A. Toutes les autres marques de commerce appartiennent à leurs propriétaires respectifs. Tous droits réservés. Fabriqué en RPC.